

SG 7600

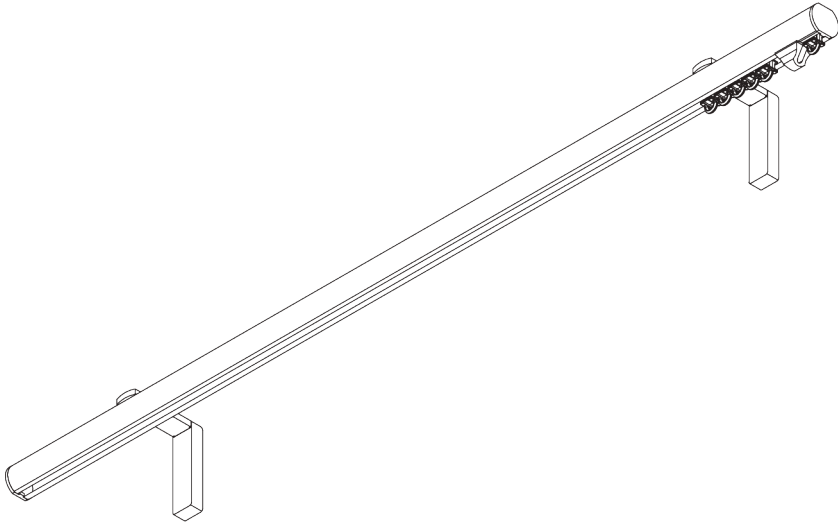
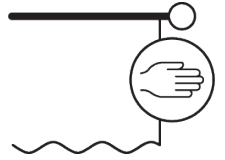

PRODUCT INFORMATION

- **Operation:** hand
- **Range:** S
- **Fitting:** ceiling, wall
- **Colours:** white RAL 9016, various colours / finishes
- **Fabrics:** refer to Silent Gliss fabric collection

Features:

- 2-component (2C) glider technology
- Wave (2C)
- Matching endcaps and brackets / bracket covers
- Range of decorative finials
- Bendable

SYSTEM SPECIFICATIONS

A. PROFILE

Profile and bending information

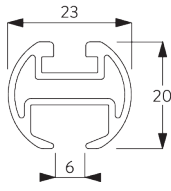

SG 11606

Profile

Radius:
✓ 15 cm, 20 cm, >25 cm

B. HOW TO MEASURE

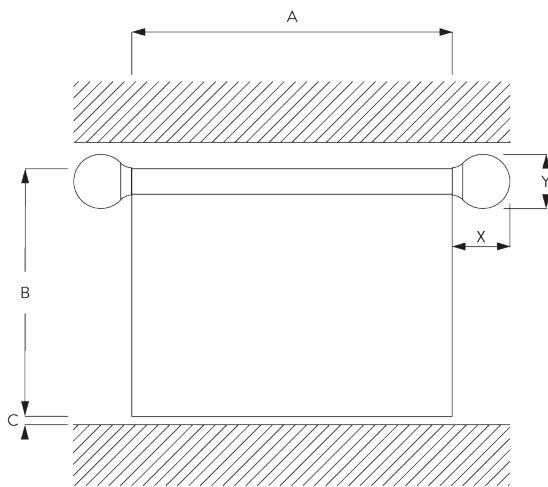

A: System width without finials









B: System height

C: Distance between floor and fabric

X: Finial width

Y: Finial height

Finial Measurements

		23 mm	
		X	Y
	SG 11602	2	23
	SG 11621	8	27
	SG 11622	14	38
	SG 11723	53	23
	SG 11724	55	40
	SG 11726	49	46
	SG 11727	89	37
	SG 11728	20	69
	SG 11729	18	46

C. SPECIFICATION

TEXT

Silent Gliss SG 7600 'Metropole' hand operated curtain track system. Comprises 23 mm round aluminium profile SG 11606 supplied made to measure with gliders SG 11300 at 14/m, 2no. end stops SG 6065 and 2 no. flush end covers SG 11602. Straight poles supplied as standard with wall 'face' fix Smart Fix brackets SG 11206 at max. 600 mm centres. Optional wall fix brackets SG 11207-11208 / SG 11216-11218 / SG 11209 / SG 11472 / Fillet bracket SG 11669. Bent systems for wall 'face' fix supplied as standard with adjustable Smart Fix bracket SG 11209. Ceiling 'top' fix with plate SG 6151 / bracket SG 6175 / SG 11668 at max. 600 mm centres. Finished in White, Matt White, Ecru, Silver Anodised, Gunmetal, Charcoal and Chrome Effect. A range of decorative finials are available (limited range for Silver Anodised and Chrome). Silent Gliss Wave option is available using 60mm glider cord SG 11303 / 80 mm glider cord SG 11302.

FITTING

A. FITTING INFORMATION

For detailed fitting information, visit the Silent Gliss website.

Fixing points

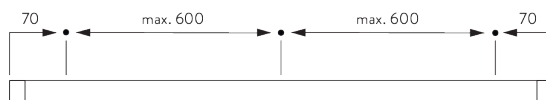

B. CEILING FITTING

Support SG 6151

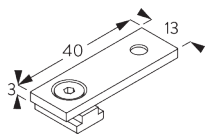
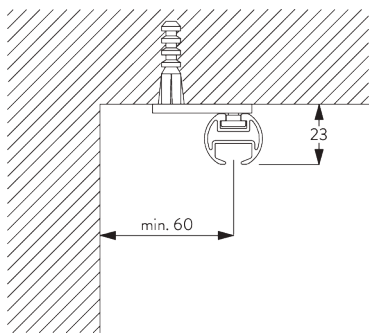

SG 6151

Ceiling support set 3 mm

Top fix bracket SG 11668

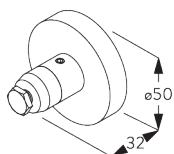
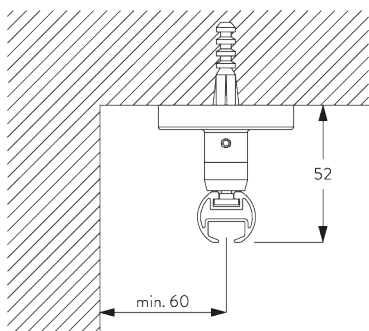

SG 11668

Top fix bracket

Mini hanger SG 6175

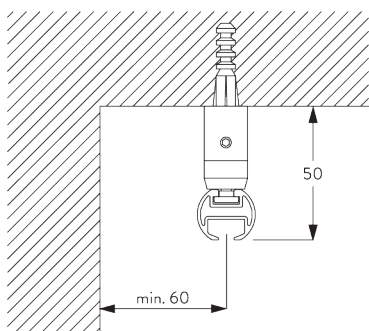

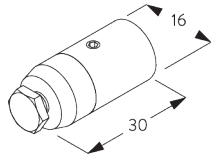

SG 6175

Mini hanger

C. WALL FITTING

Smart Fix

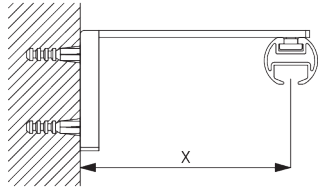

Smart Fix with slot SG 11206 - SG 11208 and SG 6141:
Screw SG 6783 (M4x10) needed.

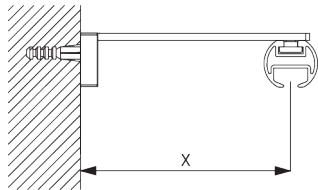

Square Smart Fix with slot SG 11216 - SG 11218 and SG 6141:
Screw SG 6783 (M4x10) needed.

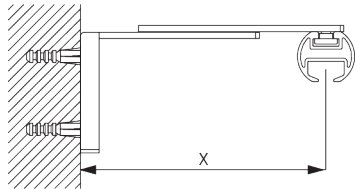

Adjustable Smart Fix SG 11209 and SG 6141:
Screw SG 6784 (M4x8) needed.

Note: all bent Metropole systems are supplied with adjustable bracket SG 11209 as standard.

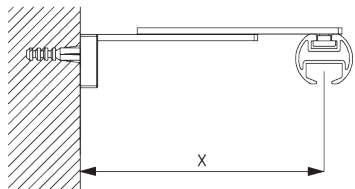

Adjustable Square Smart Fix SG 11472 and SG 6141:
Screw SG 6784 (M4x8) needed.

Smart Fix	X mm	Y mm	Z mm
SG 11206 / SG 11216	51		
SG 11207 / SG 11217	71		
SG 11208 / SG 11218	91		
SG 11209 / SG 11472	80-100		
SG 11154	102-130		
SG 11155	132-160	68	65-72
SG 11156	182-210	68	65-123

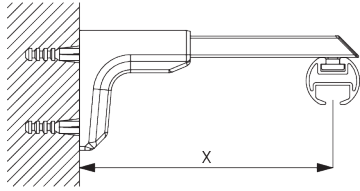

Universal Smart Fix SG 11154 - SG 11156 and SG 6141:
Screw SG 11131 (M4x6) needed.

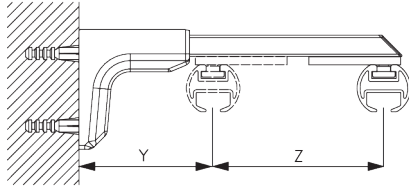

Double System:
Universal Smart Fix SG 11155 - SG 11156 and SG 6151:
Screw SG 11127 (M4x10) and nut SG 11148 needed.

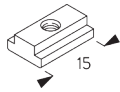

SG 6141
Clamping piece

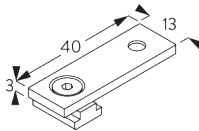

SG 6151
Ceiling support set 3 mm



SG 6783
Hexagon socket countersunk screw M4x10 mm



SG 6784
Hexagon socket countersunk screw M4x8 mm



SG 11127
Countersunk head screw M4x10



SG 11131
Pan head screw with flange M4x6



SG 11148
Nut

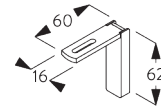

SG 11206
Smart Fix with slot 60 mm

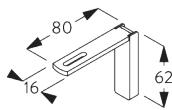

SG 11207
Smart Fix with slot 80 mm

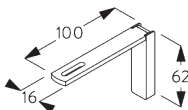

SG 11208
Smart Fix with slot 100 mm

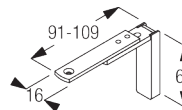

SG 11209
Adjustable Smart Fix

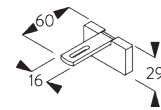

SG 11216
Square Smart Fix with slot 60 mm

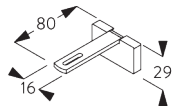

SG 11217
Square Smart Fix with slot 80 mm

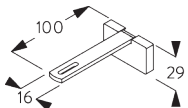

SG 11218
Square Smart Fix with slot 100 mm

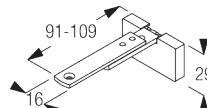

SG 11472
Adjustable Square Smart Fix

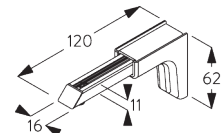

SG 11154
Universal Smart Fix 120 mm

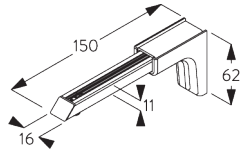

SG 11155
Universal Smart Fix 150 mm

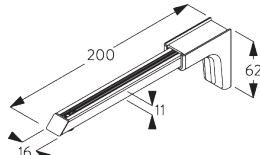

SG 11156
Universal Smart Fix 200 mm

Fillet Bracket SG 11669

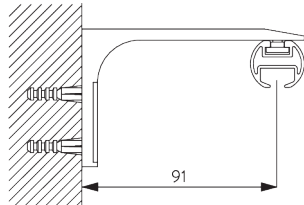

Screw SG 6784 (M4x8) needed.
Recommended for straight systems only.

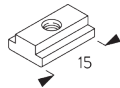

SG 6141
Clamping piece



SG 6784
Hexagon socket countersunk
screw M4x8 mm

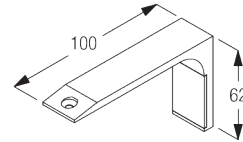

SG 11669
Fillet bracket

DESIGN & SYSTEM OPTIONS

A. ENDCAPS



SG 11602



SG 11621



SG 11622

Endcaps:

- SG 11602 Flush endcap 23 mm
- SG 11621 Stud endcap 23 mm
- SG 11622 Design endcap 23 mm

Please note:

- Without finials, poles are supplied as standard with flush fitting endcaps SG 11602 (left).
- Alternatively, stud endcaps SG 11621 can be selected at no additional cost.

B. FINIALS

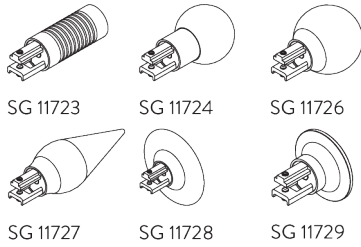

Finials are decorative elements that fit on at the end of the pole:

- SG 11723 Groove cylinder 23 mm
- SG 11724 Glass ball 23 mm
- SG 11726 Ball end 23 mm
- SG 11727 Spear 23 mm
- SG 11728 Ellipse 23 mm
- SG 11729 Taper 23 mm

C. WAVE

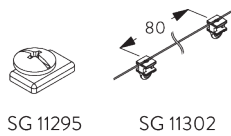
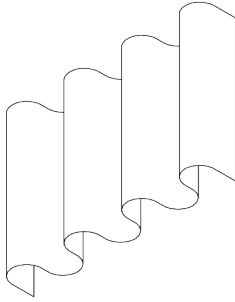

Standard components:

- SG 11295 End stop
- SG 11302 Wave 2C glider cord 80 mm

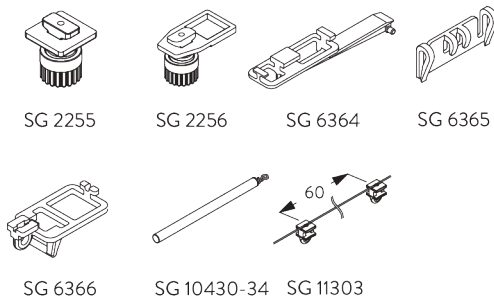

Optional components (min. Radius >25 cm):

- SG 2255 Brake
- SG 2256 Brake
- SG 6364 Wave extension
- SG 6365 Wave hanger
- SG 6366 Wave carrier for draw rod
- SG 10430-34 Draw rod
- SG 11303 Wave 2C glider cord 60 mm

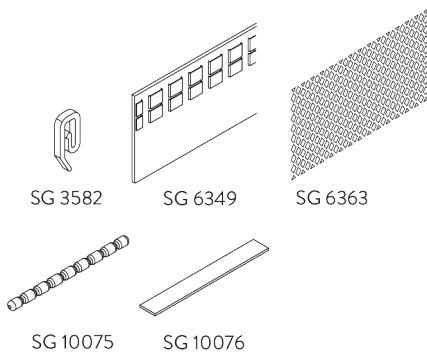

Curtain components:

- SG 3582 Hook
- SG 6349 Wave curtain tape
- SG 6363 Wave top hemming tape
- SG 10075 Lead weight 50 gr/m
- SG 10076 Fabric weigh

Wave stack depth - 2C glider cord (standard components)

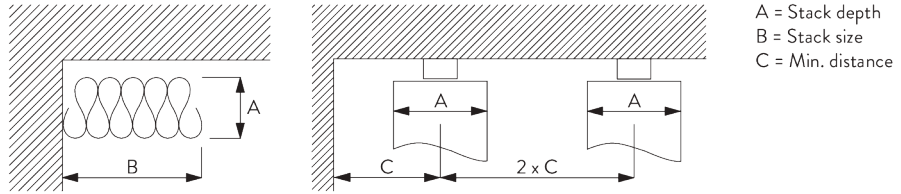

2C Glider cord SG 11302	Pockets between hooks	Approx. curtain fullness	Stack depth A	Stack size B*	Min distance C
80	6	~2.1	140	180 per metre of track	90
80	7	~2.3	160	180 per metre of track	100

2C Glider cord SG 11303	Pockets between hooks	Approx. curtain fullness	Stack depth A	Stack size B*	Min distance C
60	4	~2.1	100	230 per metre of track	70
60	5	~2.3	120	230 per metre of track	80

*Stack size B when using optional extension arm SG 6364
increases by 95 mm per curtain stack!

PARTS

A. STANDARD PARTS



SG 6065

End stop



SG 6141

Clamping piece

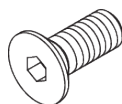

SG 6783

Hexagon socket countersunk screw
M4x10 mm

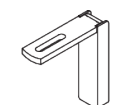

SG 11206

Smart Fix with slot 60 mm



SG 11300

2C glider

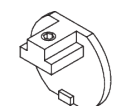

SG 11602

Flush end cap 23 mm



SG 11606

Profile

B. OPTIONAL PARTS

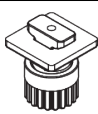

SG 2255

Brake



SG 2256

Brake



SG 3582

Hook

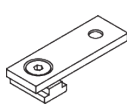

SG 6151

Ceiling support set 3 mm

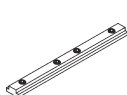

SG 6173

Connection bridge

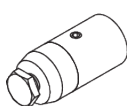

SG 6175

Mini hanger

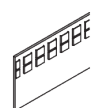

SG 6349

Wave curtain tape



SG 6363

Wave top hemming tape

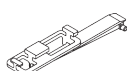

SG 6364

Wave extension

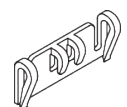

SG 6365

Wave hanger

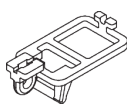

SG 6366

Wave carrier for draw rod

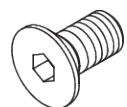

SG 6784

Hexagon socket countersunk screw
M4x8 mm

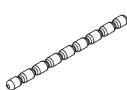

SG 10075

Lead weight 50 g/m



SG 10076

Fabric weight

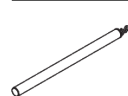

SG 10430

Draw rod 50 cm



SG 10431

Draw rod 75 cm



SG 10432

Draw rod 100 cm

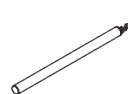

SG 10433

Draw rod 125 cm

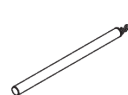

SG 10434

Draw rod 150 cm

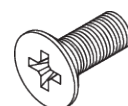

SG 11127

Countersunk head screw M4x10

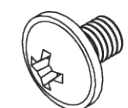

SG 11131

Pan head screw with flange M4x6

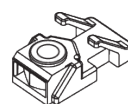

SG 11148

Nut

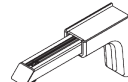

SG 11154

Universal Smart Fix 120 mm

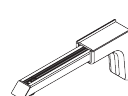

SG 11155

Universal Smart Fix 150 mm

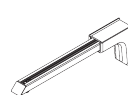

SG 11156

Universal Smart Fix 200 mm

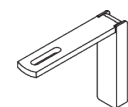

SG 11207

Smart Fix with slot 80 mm

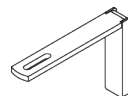

SG 11208

Smart Fix with slot 100 mm

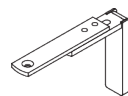

SG 11209

Adjustable Smart Fix

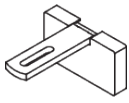
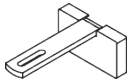
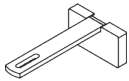
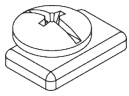
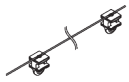
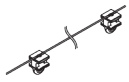
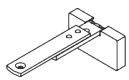
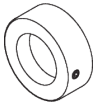
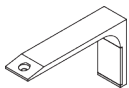
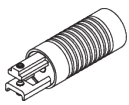
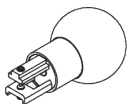
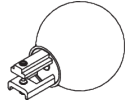
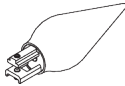
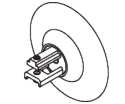
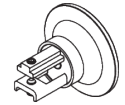
**SG 11216***Square Smart Fix with slot 60 mm***SG 11217***Square Smart Fix with slot 80 mm***SG 11218***Square Smart Fix with slot 100 mm***SG 11295***End stop***SG 11301***2C glider on strip***SG 11302***Wave 2C glider cord 80 mm***SG 11303***Wave 2C glider cord 60 mm***SG 11472***Adjustable Square Smart Fix***SG 11621***Stud endcap 23 mm***SG 11622***Design endcap 23 mm***SG 11668***Top fix bracket***SG 11669***Fillet bracket***SG 11723***Groove cylinder 23 mm***SG 11724***Glass ball 23 mm***SG 11726***Ball end 23 mm***SG 11727***Spear 23 mm***SG 11728***Ellipse 23 mm***SG 11729***Taper 23 mm*

