

SG 7620

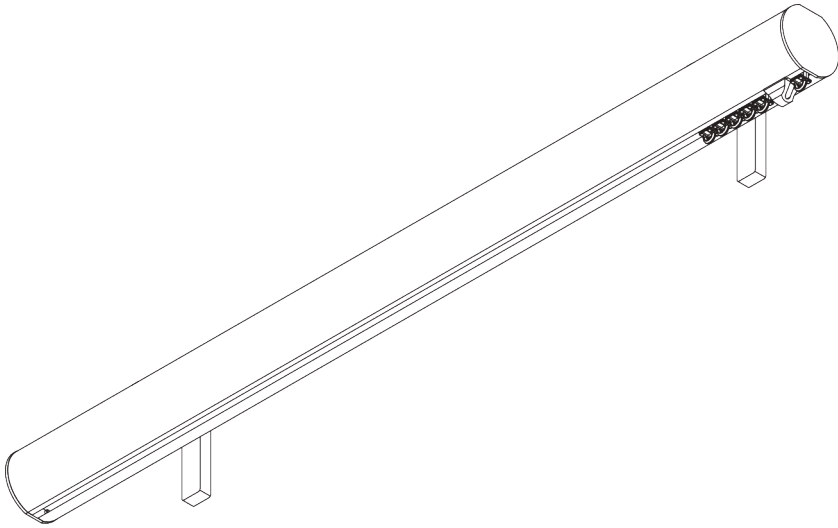
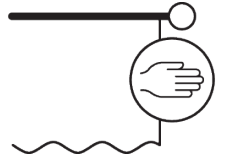

PRODUCT INFORMATION

- **Operation:** hand
- **Range:** M - L
- **Fitting:** ceiling, wall
- **Colours:** white RAL 9016, various colours / finishes
- **Fabrics:** refer to Silent Gliss fabric collection

Features:

- 2-component (2C) glider technology
- Wave (2C)
- Matching endcaps and brackets / bracket covers
- Range of decorative finials
- Bendable

SYSTEM SPECIFICATIONS

A. PROFILE

Profile and bending information

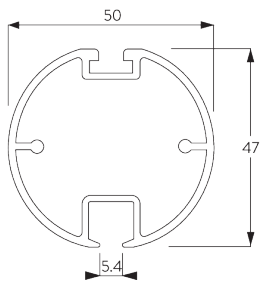

SG 11609

Profile





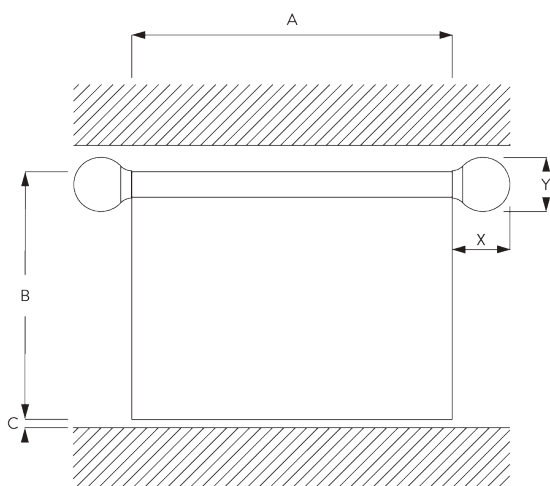



Radius:
>50 cm

B. HOW TO MEASURE



A: System width without finials
B: System height
C: Distance between floor and fabric
X: Finial width
Y: Finial height

Finial Measurements

| | | 50 mm | |
|---|----------|-------|-----|
| | | X | Y |
|  | SG 11605 | 2 | 51 |
|  | SG 11651 | 10 | 56 |
|  | SG 11652 | 24 | 75 |
|  | SG 11773 | 115 | 51 |
|  | SG 11774 | 83 | 70 |
|  | SG 11776 | 90 | 85 |
|  | SG 11777 | 165 | 70 |
|  | SG 11778 | 32 | 130 |
|  | SG 11779 | 30 | 100 |

C. SPECIFICATION

TEXT

Silent Gliss SG 7620 'Metropole' hand operated curtain track system. Comprises 50 mm aluminium profile SG 11607 supplied made to measure with 2C gliders SG 11300 at 14/m, 2 no. end covers SG 11605 and 2 no. end stops SG 6065. Straight poles supplied as standard with wall 'face' fix Smart Fix brackets SG 11206 at max. 600 mm centres. Optional wall fix brackets SG 11207-11208 / SG 11216-11218 / SG 11209 / SG 11472 / Fillet bracket SG 11669. Bent systems for wall 'face' fix supplied as standard with adjustable Smart Fix bracket SG 11209. Ceiling 'top' fix with plate SG 6152 / bracket SG 6175 / SG 11668 at max. 600 mm centres. Finished in Black, White, Matt White, Ecu, Slate Grey, Bronze, Antique Bronze, Silver Anodised, Anodic Grey and Taupe. A range of decorative finials are available. Silent Gliss Wave option is available using 60 mm glider cord SG 11303 / 80 mm glider cord SG 11302 / 80 mm roller glider cord SG 6099.

FITTING

A. FITTING INFORMATION

Fixing points

For detailed fitting information, visit the [Silent Gliss website](#).

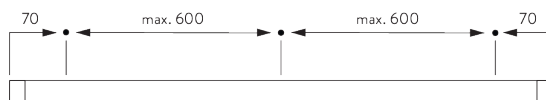

B. CEILING FITTING

Support SG 6152

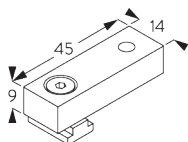
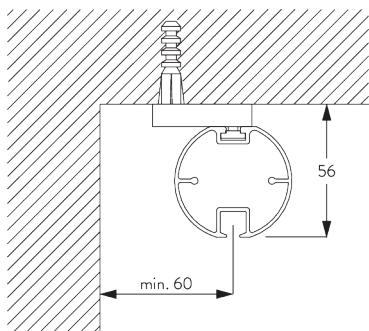

SG 6152

Ceiling support set 9 mm

Top fix bracket SG 11668

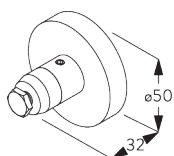
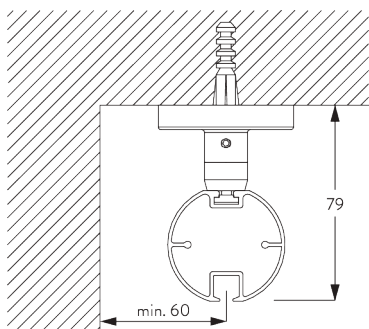

SG 11668

Top fix bracket

Mini hanger SG 6175

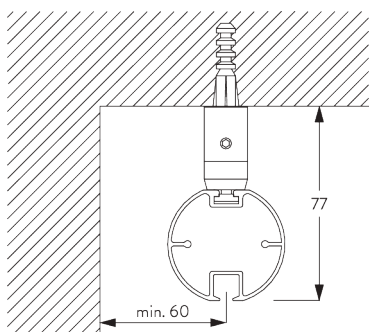

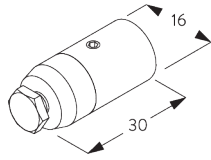

SG 6175

Mini hanger

C. WALL FITTING

Smart Fix

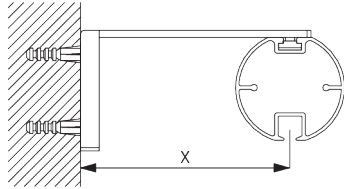

Smart Fix with slot SG 11206 - SG 11208 and SG 6141:
Screw SG 6783 (M4x10) needed.

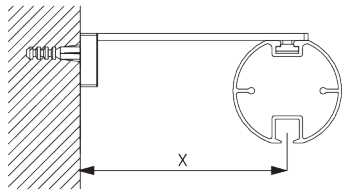

Square Smart Fix with slot SG 11216 - SG 11218 and SG 6141:
Screw SG 6783 (M4x10) needed.

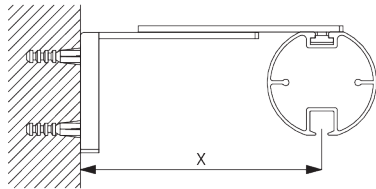

Adjustable Smart Fix SG 11209 and SG 6141:
Screw SG 6784 (M4x8) needed.

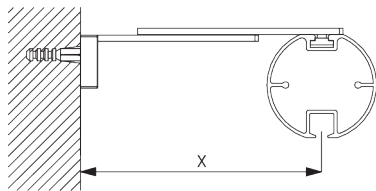

Adjustable Square Smart Fix SG 11472 and SG 6141:
Screw SG 6784 (M4x8) needed.

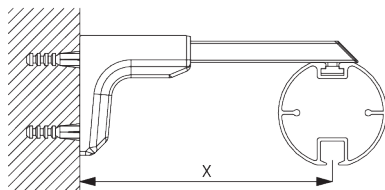

Universal Smart Fix SG 11154 - SG 11156 and SG 6141:
Screw SG 11131 (M4x6) needed.

| Smart Fix | X mm | Y mm | Z mm |
|---------------------|---------|------|--------|
| SG 11206 / SG 11216 | 51 | | |
| SG 11207 / SG 11217 | 71 | | |
| SG 11208 / SG 11218 | 91 | | |
| SG 11209 / SG 11472 | 80-100 | | |
| SG 11154 | 102-130 | | |
| SG 11155 | 132-160 | 68 | 65-72 |
| SG 11156 | 182-210 | 68 | 65-123 |

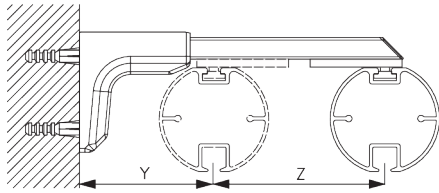

Double System:

Universal Smart Fix SG 11155 - SG 11156 and SG 6151:

Screw SG 11127 (M4x10) and nut SG 11148 needed.

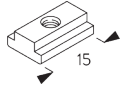

SG 6141
Clamping piece

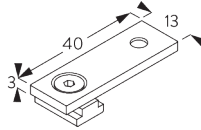

SG 6151
Ceiling support set 3 mm



SG 6783
Hexagon socket countersunk screw M4x10 mm



SG 6784
Hexagon socket countersunk screw M4x8 mm



SG 11127
Countersunk head screw M4x10



SG 11131
Pan head screw with flange M4x6



SG 11148
Nut

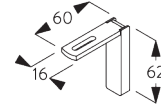

SG 11206
Smart Fix with slot 60 mm

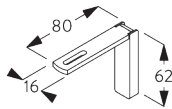

SG 11207
Smart Fix with slot 80 mm

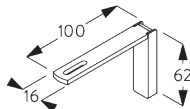

SG 11208
Smart Fix with slot 100 mm

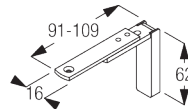

SG 11209
Adjustable Smart Fix

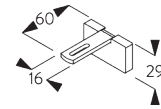

SG 11216
Square Smart Fix with slot 60 mm

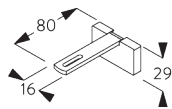

SG 11217
Square Smart Fix with slot 80 mm

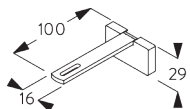

SG 11218
Square Smart Fix with slot 100 mm

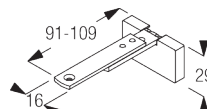

SG 11472
Adjustable Square Smart Fix

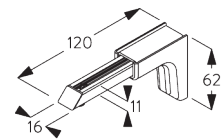

SG 11154
Universal Smart Fix 120 mm

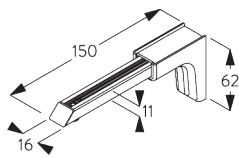

SG 11155
Universal Smart Fix 150 mm

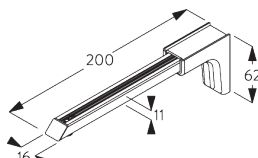

SG 11156
Universal Smart Fix 200 mm

**Fillet Bracket
SG 11669**

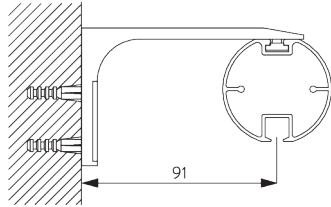

Screw SG 6784 (M4x8) needed.
Recommended for straight systems only.

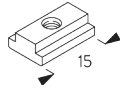

SG 6141
Clamping piece



SG 6784
Hexagon socket countersunk
screw M4x8 mm

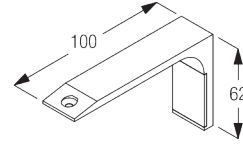

SG 11669
Fillet bracket

DESIGN & SYSTEM OPTIONS

A. ENDCAPS



SG 11605



SG 11651



SG 11652

Endcaps:

- SG 11605 Flush endcap 50 mm
- SG 11651 Stud endcap 50 mm
- SG 11652 Design endcap 50 mm

Please note:

- Without finials, poles are supplied as standard with flush fitting endcaps SG 11605 (left).
- Alternatively, stud endcaps SG 11651 can be selected at no additional cost.

B. FINIALS

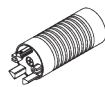

SG 11773



SG 11774



SG 11776

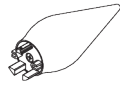

SG 11777



SG 11778



SG 11779

Finials are decorative elements that fit on at the end of the pole:

- SG 11773 Groove cylinder 50 mm
- SG 11774 Glass ball 50 mm
- SG 11776 Ball end 50 mm
- SG 11777 Spear 50 mm
- SG 11778 Ellipse 50 mm
- SG 11779 Taper 50 mm

C. WAVE

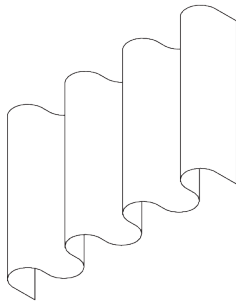

SG 11295

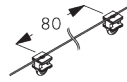

SG 11302

Standard components:

- SG 11295 End stop
- SG 11302 Wave 2C glider cord 80 mm



SG 2255



SG 2256

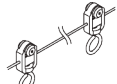

SG 6099

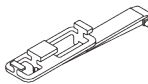

SG 6364

Optional components:

- SG 2255 Brake
- SG 2256 Brake
- SG 6099 Wave roller cord 80 mm
- SG 6364 Wave extension
- SG 6365 Wave hanger
- SG 6366 Wave carrier for draw rod
- SG 10430-34 Draw rod
- SG 11303 Wave 2C glider cord 60 mm



SG 6365

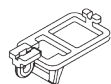

SG 6366

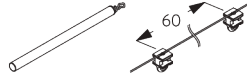

SG 10430-34

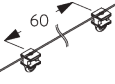

SG 11303



SG 3582

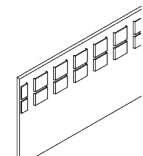

SG 6349

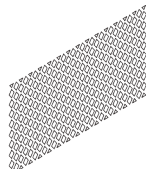

SG 6363

Curtain components:

- SG 3582 Hook
- SG 6349 Wave curtain tape
- SG 6363 Wave top hemming tape
- SG 10075 Lead weight 50 gr/m
- SG 10076 Fabric weigh

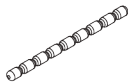

SG 10075



SG 10076

Wave stack depth - 2C glider cord (standard components)

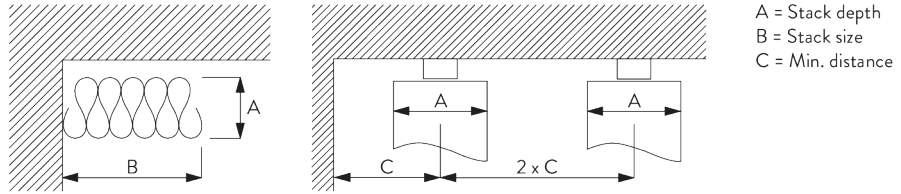

| 2C Glider cord SG 11302 | Pockets between hooks | Approx. curtain fullness | Stack depth A | Stack size B* | Min distance C |
|----------------------------|--------------------------|-----------------------------|------------------|---------------------------|-------------------|
| 80 | 6 | ~2.1 | 140 | 180 per metre of track | 90 |
| 80 | 7 | ~2.3 | 160 | 180 per metre of track | 100 |

| 2C Glider cord SG 11303 | Pockets between hooks | Approx. curtain fullness | Stack depth A | Stack size B* | Min distance C |
|----------------------------|--------------------------|-----------------------------|------------------|---------------------------|-------------------|
| 60 | 4 | ~2.1 | 100 | 230 per metre of track | 70 |
| 60 | 5 | ~2.3 | 120 | 230 per metre of track | 80 |

*Stack size B when using optional extension arm SG 6364 increases by 95 mm per curtain stack!

PARTS

A. STANDARD PARTS



SG 6065

End stop



SG 6141

Clamping piece

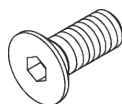

SG 6783

Hexagon socket countersunk screw
M4x10 mm

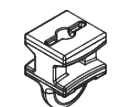

SG 11300

2C glider



SG 11605

Flush end cap 50 mm

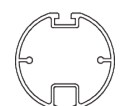

SG 11609

Profile

B. OPTIONAL PARTS

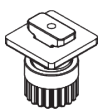

SG 2255

Brake



SG 2256

Brake



SG 3582

Hook

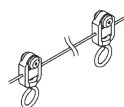

SG 6099

Wave roller cord 80 mm

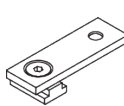

SG 6151

Ceiling support set 3 mm

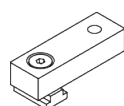

SG 6152

Ceiling support set 9 mm

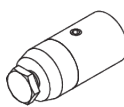

SG 6175

Mini hanger



SG 6283

Roller



SG 6349

Wave curtain tape



SG 6363

Wave top hemming tape

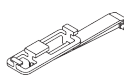

SG 6364

Wave extension

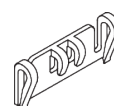

SG 6365

Wave hanger

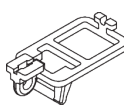

SG 6366

Wave carrier for draw rod

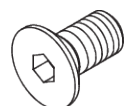

SG 6784

Hexagon socket countersunk screw
M4x8 mm



SG 10075

Lead weight 50 g/m

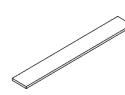

SG 10076

Fabric weight

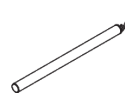

SG 10430

Draw rod 50 cm

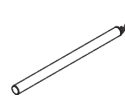

SG 10431

Draw rod 75 cm

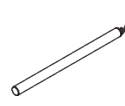

SG 10432

Draw rod 100 cm

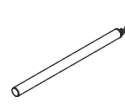

SG 10433

Draw rod 125 cm

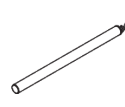

SG 10434

Draw rod 150 cm

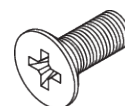

SG 11127

Countersunk head screw M4x10

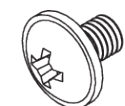

SG 11131

Pan head screw with flange M4x6

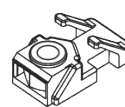

SG 11148

Nut

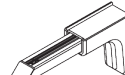

SG 11154

Universal Smart Fix 120 mm

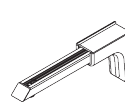

SG 11155

Universal Smart Fix 150 mm

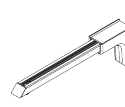

SG 11156

Universal Smart Fix 200 mm

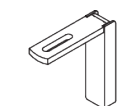

SG 11206

Smart Fix with slot 60 mm

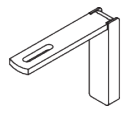

SG 11207

Smart Fix with slot 80 mm

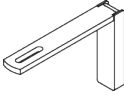

SG 11208

Smart Fix with slot 100 mm

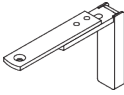

SG 11209

Adjustable Smart Fix

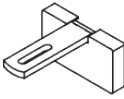

SG 11216

Square Smart Fix with slot 60 mm

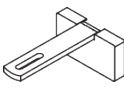

SG 11217

Square Smart Fix with slot 80 mm

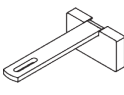

SG 11218

Square Smart Fix with slot 100 mm

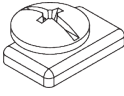

SG 11295

End stop



SG 11301

2C glider on strip

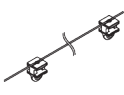

SG 11302

Wave 2C glider cord 80 mm

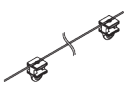

SG 11303

Wave 2C glider cord 60 mm

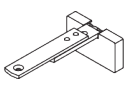

SG 11472

Adjustable Square Smart Fix



SG 11651

Stud endcap 50 mm



SG 11652

Design endcap 50 mm



SG 11668

Top fix bracket

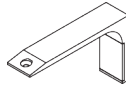

SG 11669

Fillet bracket

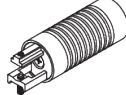

SG 11773

Groove cylinder 50 mm

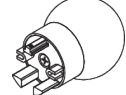

SG 11774

Glass ball 50 mm

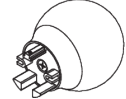

SG 11776

Ball end 50 mm

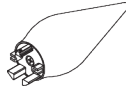

SG 11777

Spear 50 mm

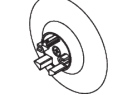

SG 11778

Ellipse 50 mm

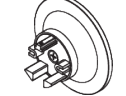

SG 11779

Taper 50 mm

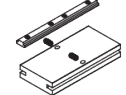

SG 11783

Connection bridge

